



# JEWISH LEADERSHIP ACADEMY

*FURNITURE SCOPE*  
*ADMIN BUILDING*



# ADMIN SECURITY OFFICE

TYP. 1

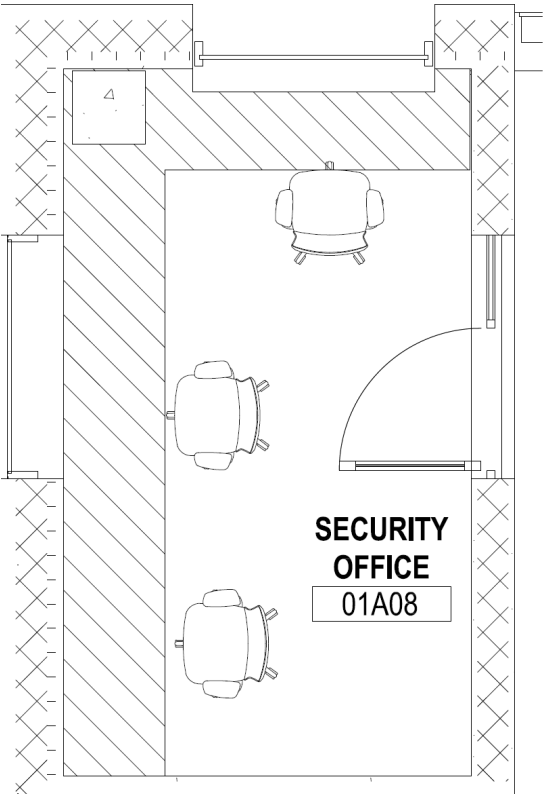

# SECURITY

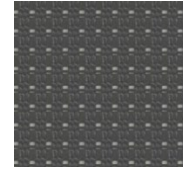
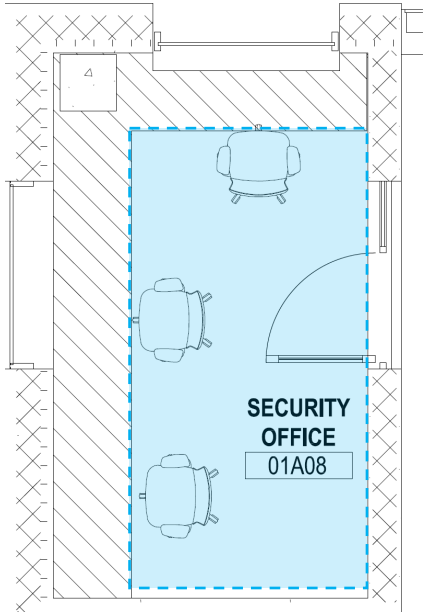

MESH: GREY



POLY: BLACK



KNOLL JOURNEY/JINGLE

## **OUSBY TASK CHAIR**

QTY. 3

### FINISHES:

MESH: GREY

COMPONENTS: BLACK

UPHOLSTERY: KNOLL: JOURNEY/JINGLE

# LOBBY/RECEPTION

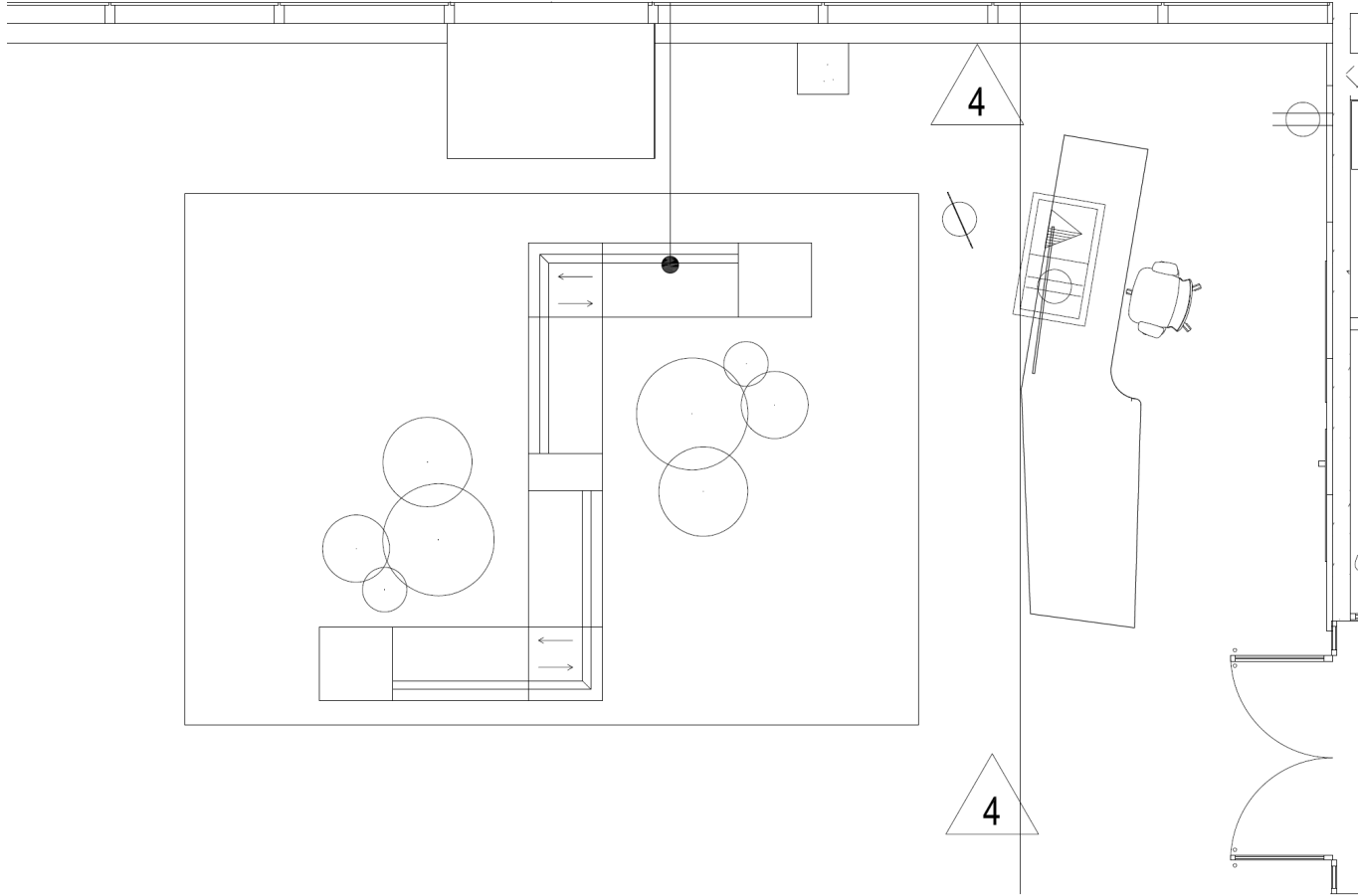

# LOBBY RECEPTION

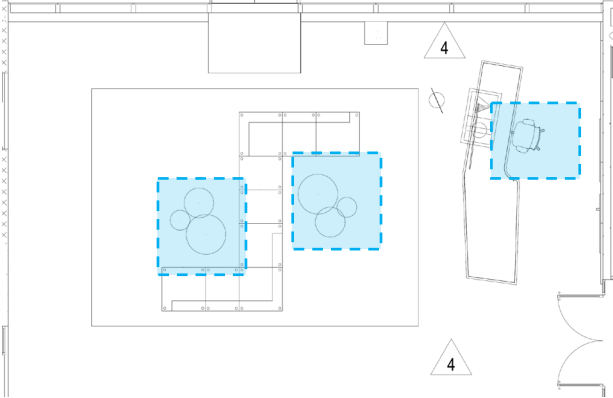

**OUSBY TASK CHAIR**

QTY. 1

FINISHES:

MESH: GREY

COMPONENTS: BLACK

UPHOLSTERY: KNOLL: JOURNEY/JINGLE

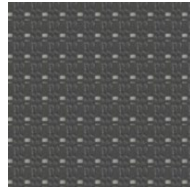

MESH: GREY



POLY: BLACK



KNOLL JOURNEY/JINGLE



**SUNDA STACK TABLES**

QTY. 6

FINISHES:

TOP: CLEAR OAK

BASE: BLACK



CLEAR OAK WOOD  
STAIN



BASE: BLACK

# LOBBY RECEPTION

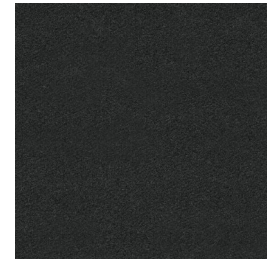
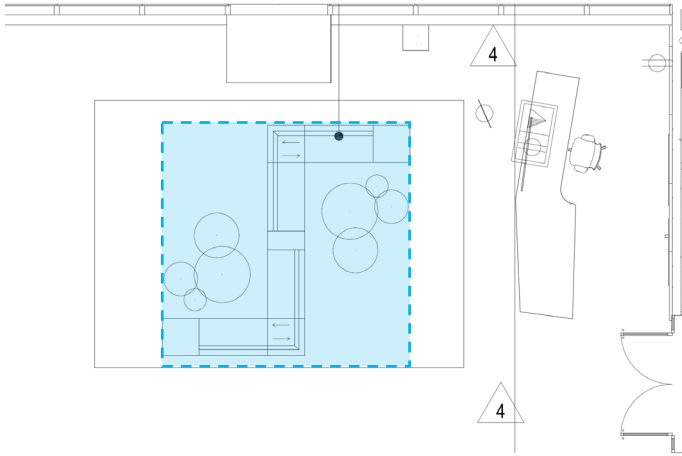

CAMIRA BLAZER/WINCHESTER

## MAYZE MODULAR LOUNGE

### FINISHES:

UPHOLSTERY: CAMIRA:  
BLAZER/WINCHESTER

### QUILTED PATTERNS FOR PILLOW

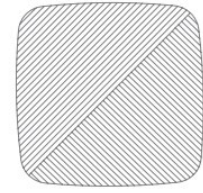

Lines

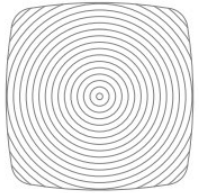

Echo

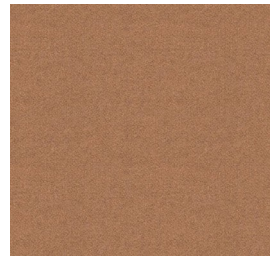

CAMIRA SYNERGY/LOOP

## TYLUS PILLOWS

### FINISHES:

UPHOLSTERY: CAMIRA: SYNERGY/LOOP

SIZES 10, 16, 20 (x2 EACH)



ADMIN IT OFFICE

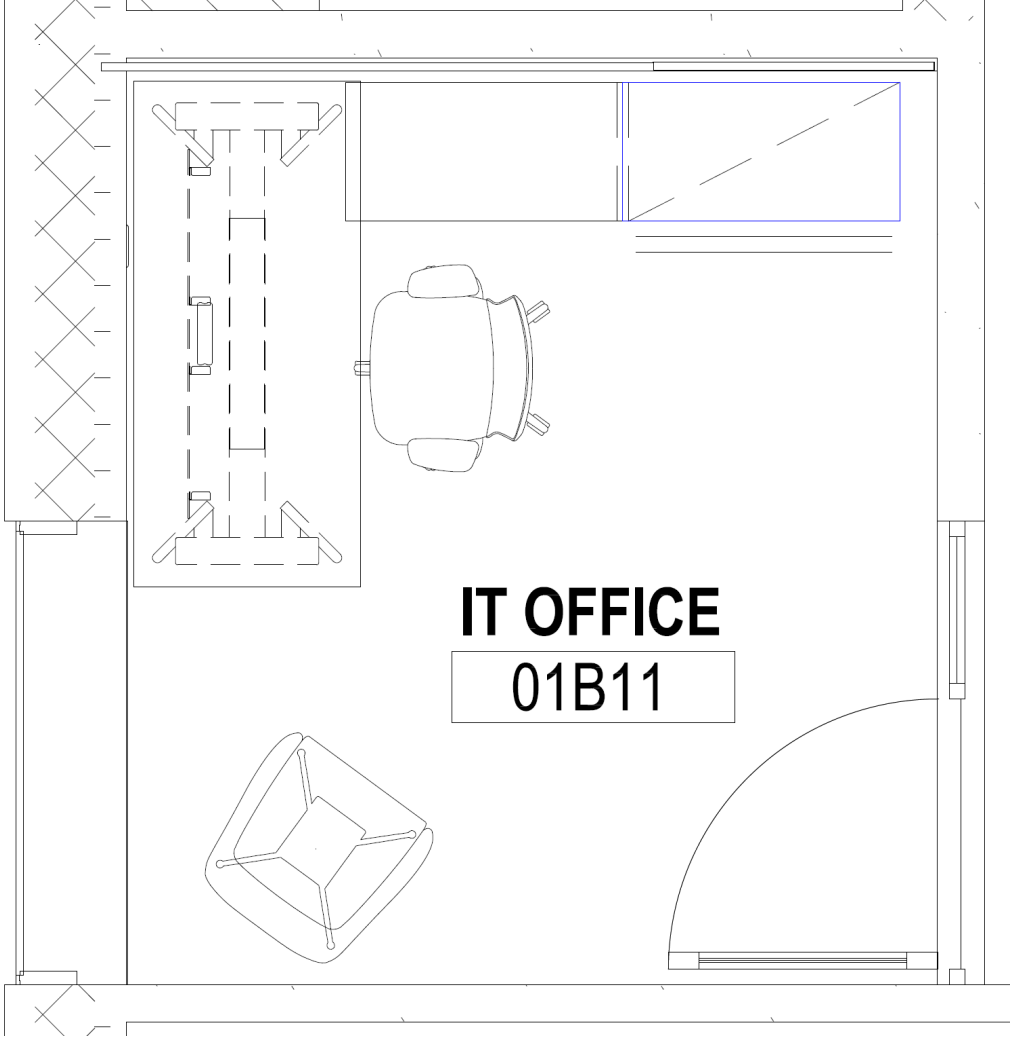

# ADMIN IT OFFICE

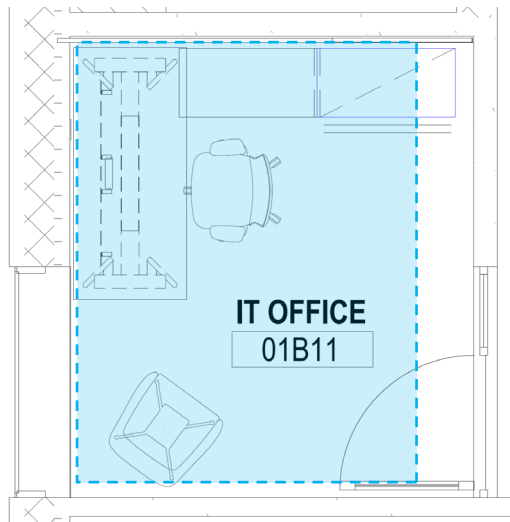

## CZ DESK

30"D x 66"W

### FINISHES:

TOP: LAMINATE DESIGNER WHITE

EDGE: FROSTY WHITE

BASE: NATURAL ON BEECH

METAL FRAME : COTTONWOOD WHITE

LAMINATE: DESIGNER WHITE

NATURAL ON BEECH

METAL FRAME: COTTONWOOD WHITE



## CALIDA SWIVEL CHAIR

QTY: 1

### FINISHES:

UPHOLSTERY: MAHARAM MODE/STROLL

BASE: POLISHED ALUMINUM

MAHARAM MODE/STROLL

METAL BASE: POLISHED ALUMINUM

## CANVAS LOW CREDENZA AND BOOKCASE

CREDENZA: 20"D X 72" W (OPEN AND CLOSED)

QTY. 1

BK CASE: 36"W X 72"H

QTY. 2

### FINISHES:

LAMINATE A: DESIGNER WHITE (TOP OF LATERAL)

LAMINATE B: SUGAR MAPLE

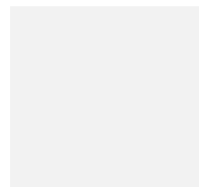

LAMINATE A: DESIGNER WHITE



LAMINATE B: SUGAR MAPLE

## FILE PULLS



## OUSBY TASK CHAIR

QTY. 1

### FINISHES:

MESH: GREY

COMPONENTS: BLACK

UPHOLSTERY: KNOLL: JOURNEY/JINGLE

MESH: GREY

POLY: BLACK

KNOLL JOURNEY/JINGLE

FOR ACCURACY OF COLOR/TEXTURE/FINISH PLEASE REFER TO PHYSICAL SAMPLES



# ADMISSIONS SUITE

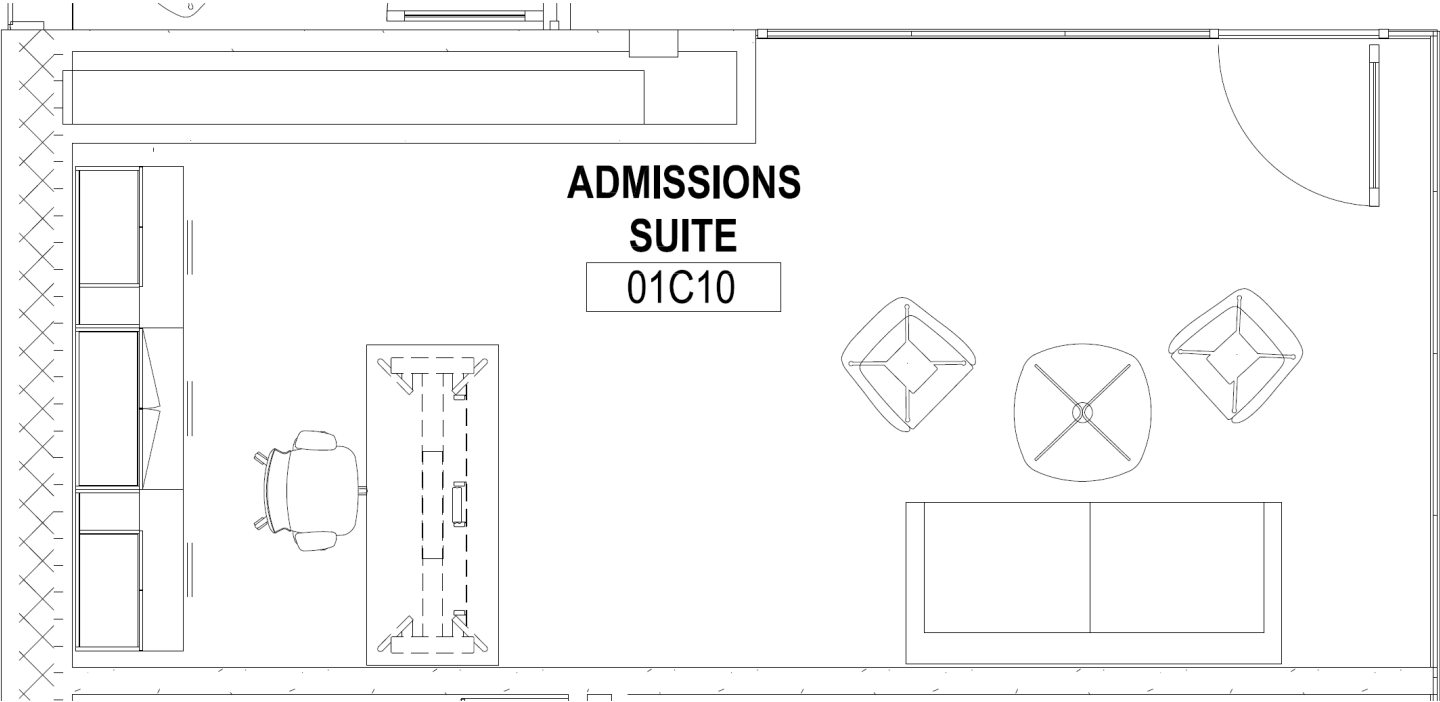

# ADMISSIONS

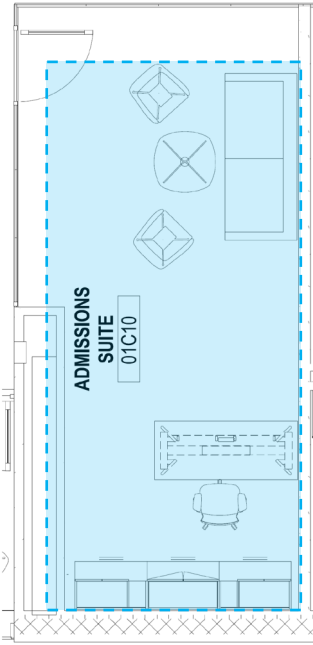

## CZ DESK

30"D x 72"W

### FINISHES:

TOP: LAMINATE DESIGNER WHITE

EDGE: FROSTY WHITE

BASE: NATURAL ON BEECH

METAL FRAME:  
COTTONWOOD WHITE

LAMINATE:  
DESIGNER WHITE



LEG: NATURAL ON BEECH

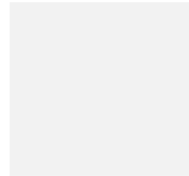

METAL FRAME:  
COTTONWOOD WHITE



## CANVAS CASEGOODS

### CONTRASTING LAM

(3) LATERAL FILES

(2) STACK ON BOOKCASES – DOORS

(1) BOOKCASES – NO DOORS

### FINISHES:

LAMINATE A: DESIGNER WHITE

LAMINATE B: SUGAR MAPLE

LAMINATE A: DESIGNER WHITE

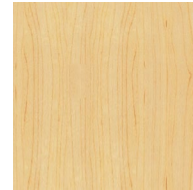

LAMINATE B: SUGAR MAPLE

### FILE PULLS



## CALIDA SWIVEL CHAIR

QTY: 1

### FINISHES:

UPHOLSTERY: MAHARAM  
MODE/STROLL

BASE: POLISHED ALUMINUM

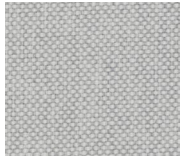

MAHARAM  
MODE/STROLL



METAL BASE:  
POLISHED ALUMINUM

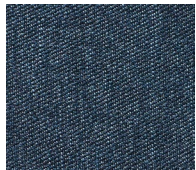

INDIGO



## ADAMS LOVE SEAT

72"W (QTY. 1)

### FINISHES:

UPHOLSTERY: INDIGO

BASE: SILVER



BASE: SILVER



## SPIRIT TABLE

(QTY. 1)

### FINISHES:

TOP: SUGAR MAPLE

BASE: ALUMINUM

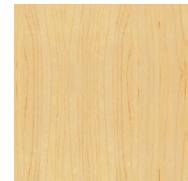

SUGAR MAPLE LAMINATE



BASE: ALUMINUM



## OUSBY TASK CHAIR

QTY. 1

### FINISHES:

MESH: GREY

COMPONENTS: BLACK

UPHOLSTERY: KNOLL: JOURNEY/JINGLE

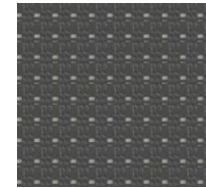

MESH: GREY

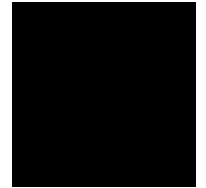

POLY: BLACK



KNOLL JOURNEY/JINGLE

# COLLEGE GUIDANCE

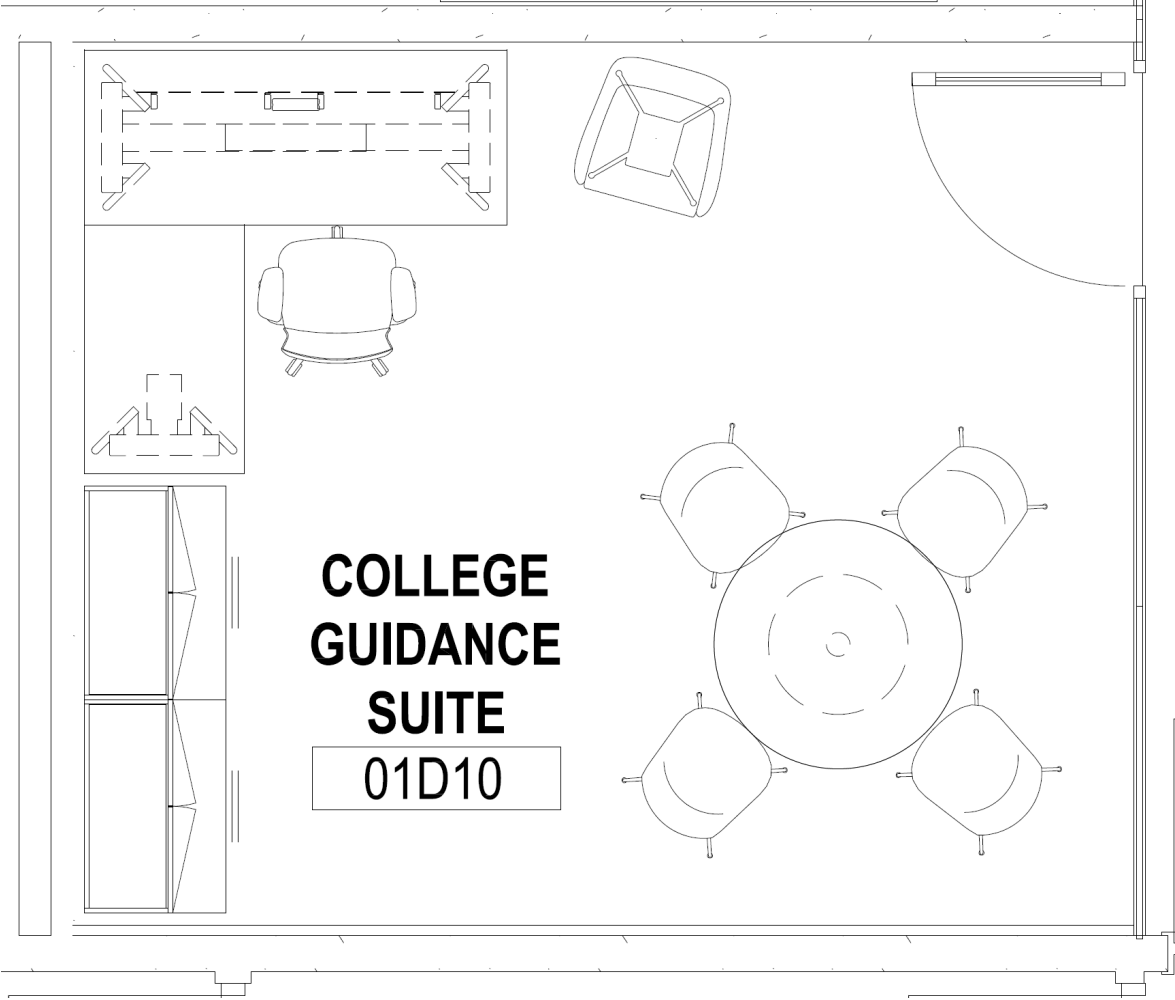

# COLLEGE GUIDANCE

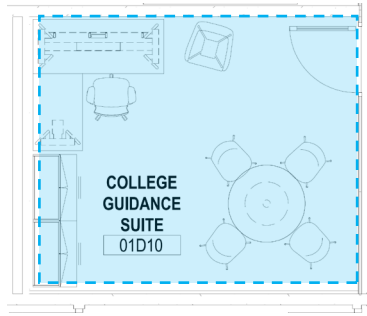

**CZ DESK WITH RETURN**

30"D x 72"W

FINISHES:

TOP: LAMINATE DESIGNER WHITE

EDGE: FROSTY WHITE

BASE: WOOD STAIN TBD

METAL FRAME UNDER SURFACE:  
COTTONWOOD WHITE

LAMINATE:  
DESIGNER WHITE

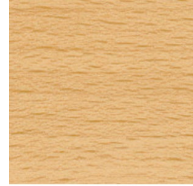

LEG: NATURAL ON BEECH

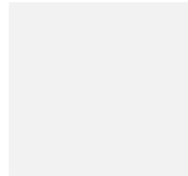

METAL FRAME:  
COTTONWOOD WHITE



**CANVAS CASEGOODS**

*CONTRASTING LAM*

(2) LATERAL FILES

(2) STACK ON BOOKCASES – NO DOORS

FINISHES:

LAMINATE A: DESIGNER WHITE

LAMINATE B: SUGAR MAPLE

PULLS: ALUMINUM

LAMINATE A: DESIGNER WHITE

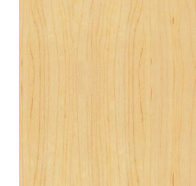

LAMINATE B: SUGAR MAPLE

**FILE PULLS**



**CALIDA SWIVEL CHAIR**

QTY: 5

FINISHES:

UPHOLSTERY: MAHARAM  
MODE/STROLL

BASE: POLISHED ALUMINUM

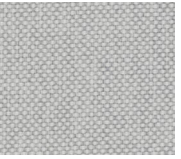

MAHARAM  
MODE/STROLL



METAL BASE:  
POLISHED ALUMINUM



LAMINATE:  
FROSTY WHITE



EDGE: BLACK

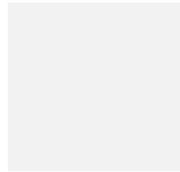

METAL BASE:  
COTTONWOOD  
WHITE

**ATHENS ROUND TABLE**

48" DIA

FINISHES:

TOP: FROSTY WHITE

EDGE: BLACK

BASE: COTTONWOOD WHITE



**OUSBY TASK CHAIR**

QTY. 1

FINISHES:

MESH: GREY

COMPONENTS: BLACK

UPHOLSTERY: KNOLL: JOURNEY/JINGLE



MESH: GREY



POLY: BLACK



KNOLL JOURNEY/JINGLE

CONFERENCE 01C08

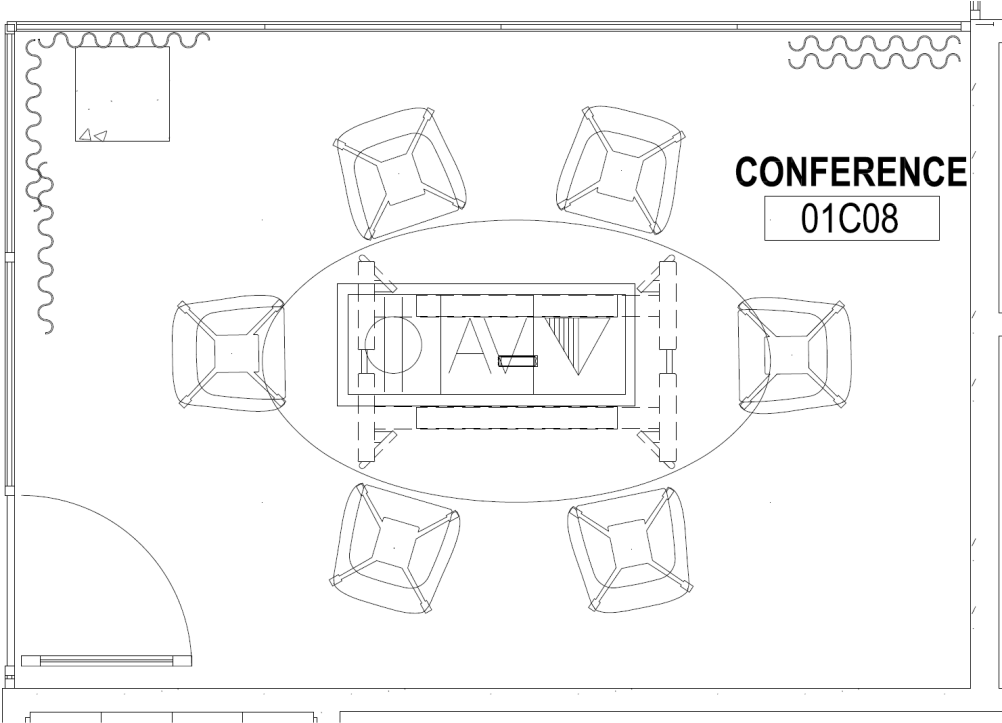

# CONFERENCE 01C08

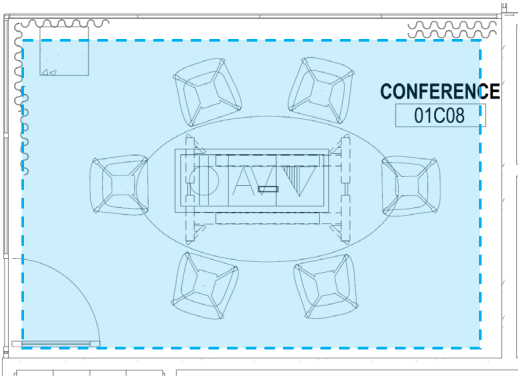

**CZ ELLIPTICAL MEETING TABLE**  
**KNIFE EDGE \*POWER MODULE**

60" D x 108"

FINISHES:

TOP: LAMINATE TBD

EDGE: TBD

BASE: WOOD STAIN TBD

METAL FRAME UNDER  
SURFACE: TBD



LAMINATE or VENEER: TBD

*\*VENEERS WOULD CORRESPOND WITH LEG  
FINISH*

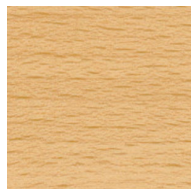

LEG: NATURAL ON BEECH

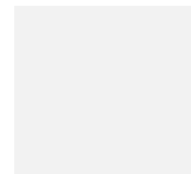

METAL FRAME: WHITE



**RIBBED CONFERENCE CHAIR**

**QTY: 6**

FINISHES:

UPHOLSTERY: TBD

BASE/FRAME: CHROME



UPHOLSTERY GREY



METAL BASE: CHROME

# MOTHERS ROOM

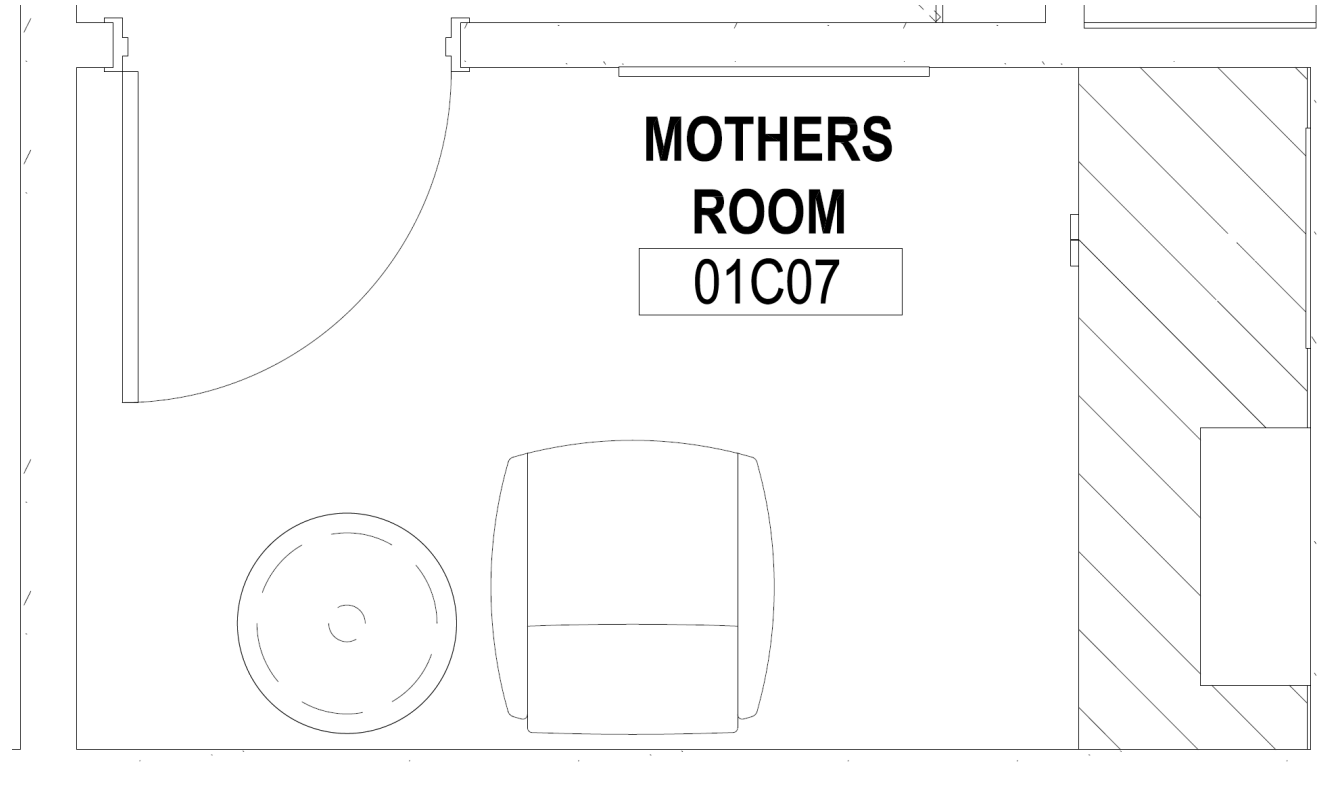

# MOTHER'S ROOM

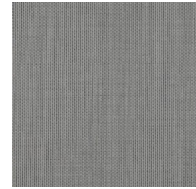
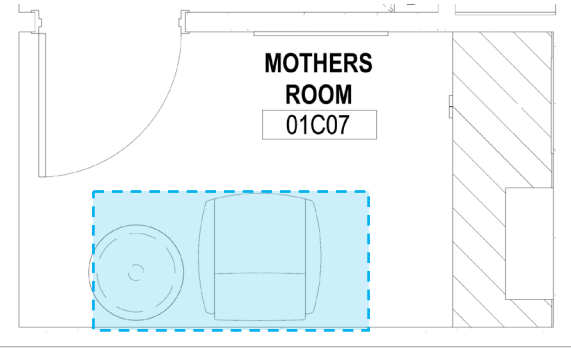

PALLAS: BOUNCE/STEEL GREY



LEG: NATURAL ON BEECH

## **AFFINA HIGH BACK**

QTY: 1

### FINISHES:

UPHOLSTERY: PALLAS:  
BOUNCE/STEEL GREY

BASE: NATURAL ON BEECH

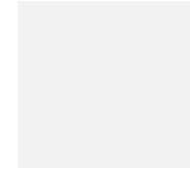

LAMINATE:  
FROSTY WHITE



EDGE: BLACK

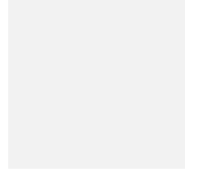

METAL BASE:  
COTTONWOOD  
WHITE

## **ATHENS TABLES**

24" DIA 36" SQ (QTY. 2)

### FINISHES:

TOP: FROSTY WHITE

EDGE: BLACK

BASE: COTTONWOOD WHITE



# NURSE'S STATION

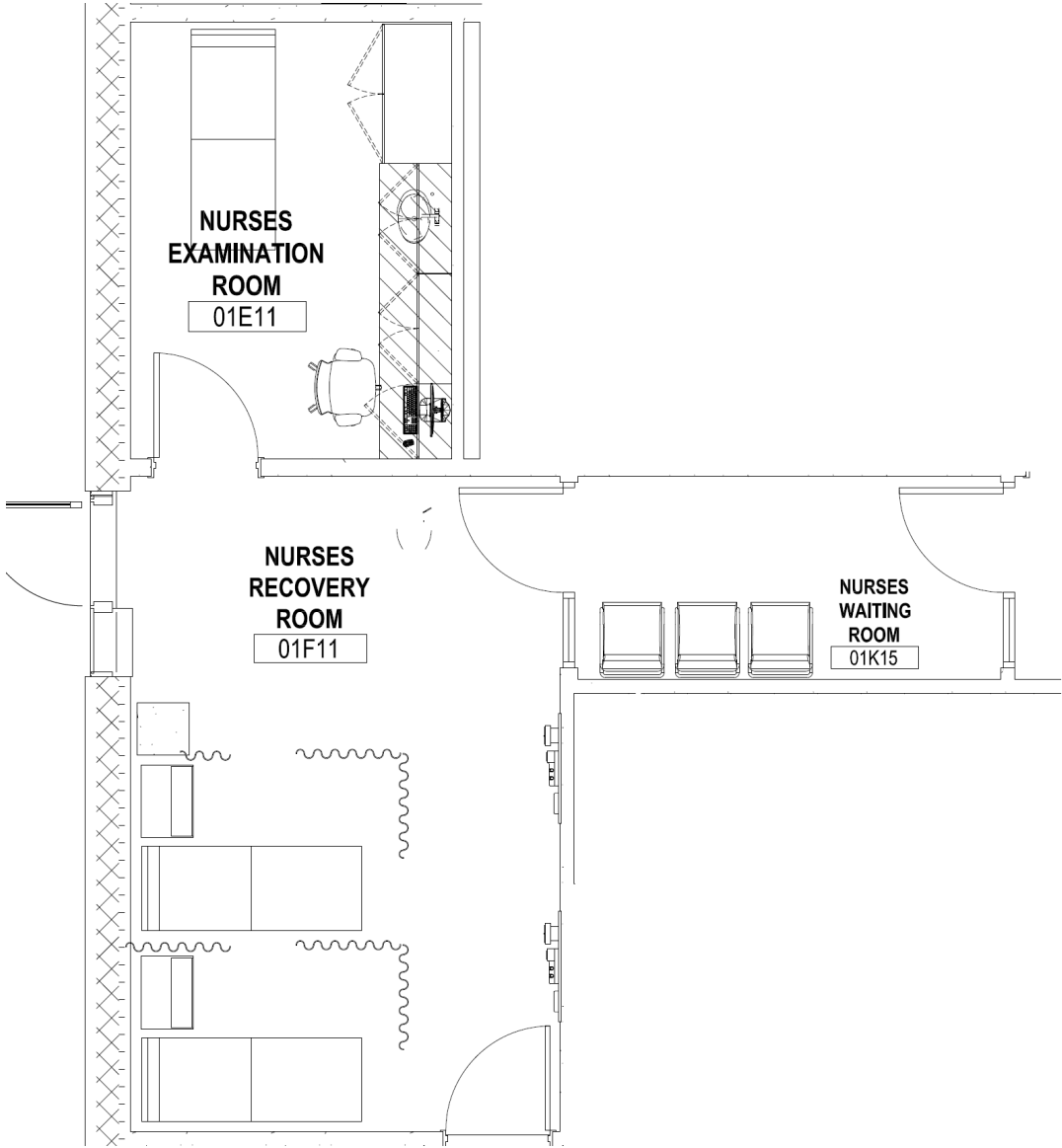

# NURSE'S STATION

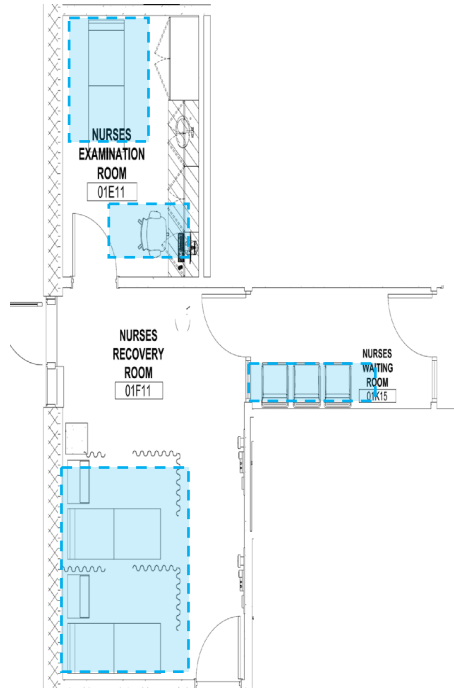

**DONI 4-LEG CHAIR**

QTY. 3

FINISHES:

POLY: BLUEGREY

BASE FRAME: BLACK



POLY: BLUE GREY



BASE: BLACK



COUNTRY MIST—3CM

**EXAM TABLE**

QTY. 3

FINISHES:

FRAME: ALUMINUM

UPHOLSTERY: COUNTRY MIST



**OUSBY TASK CHAIR**

QTY. 1

FINISHES:

MESH: GREY

COMPONENTS: BLACK

UPHOLSTERY: KNOLL: JOURNEY/JINGLE

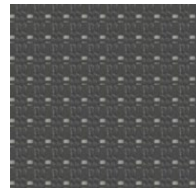

MESH: GREY



POLY: BLACK



KNOLL JOURNEY/JINGLE

# OPEN WORKSTATIONS



# OPEN WORKSTATION

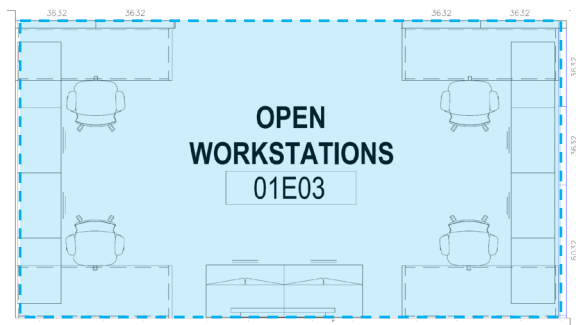

**OPEN LEG DESK**  
 24"D x 72"W  
**FINISHES**  
 TOP: LAMINATE DESIGNER WHITE  
 BASE: STARLIGHT SILVER METALLIC

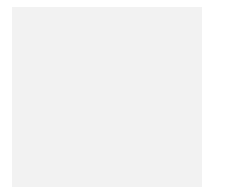

LAMINATE: DESIGNER WHITE



FRAME: STARLIGHT SILVER



**CANVAS TOP UNIT BOOKCASE**  
 QTY: 2  
 15"D x 36"W  
**FINISHES**  
 LAMINATE: SUGAR MAPLE

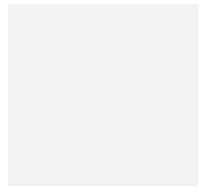

LAMINATE A: WHITE



**CANVAS DOUBLE CREDEZA**  
 QTY: 1  
 24"D x 72"W  
**FINISHES**  
 LAMINATE A: DESIGNER WHITE (TOP)  
 LAMINATE B: SUGAR MAPLE (BASE)

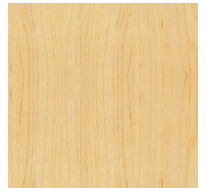

LAMINATE B: SUGAR MAPLE



**CANVAS LOW CREDEZA**  
 QTY: 4  
 24"D x 60"W  
**FINISHES (CONTRASTING LAMINATE)**  
 TOP: DESIGNER WHITE  
 BASE: SUGAR MAPLE  
 PULLS: ALUMINUM BEAM



METAL PULLS

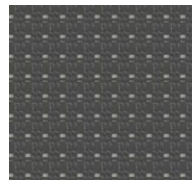

MESH: GREY

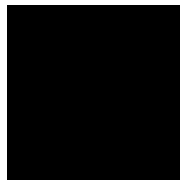

POLY: BLACK



KNOLL JOURNEY/JINGLE



**OUSBY TASK CHAIR**  
 QTY: 4  
**FINISHES:**  
 MESH: GREY  
 COMPONENTS: BLACK  
 UPHOLSTERY: KNOLL: JOURNEY/JINGLE

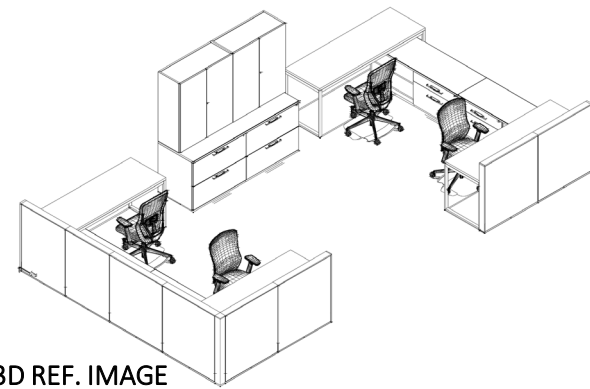

3D REF. IMAGE

**UNITE PANEL WORKSTATION**  
 40"H PANELS—LAMINATE OUTER, FABRIC INNER  
 (2) INFEEDS (1 PER SIDE) DUPLEX RACEWAY POWER  
**\*TO BE TIED INTO BUILDING POWER**  
**FINISHES**  
 TRIM: COTTONWOOD  
 PANEL FABRIC INNER: FRACTAL/SEAGULL  
 LAMINATE OUTER: KENSINGTON MAPLE

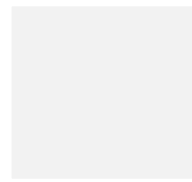

TRIM COLOR: COTTONWOOD WHITE



LAMINATE B: KENSINGTON MAPLE

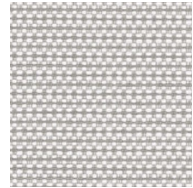

FABRIC: FRACTAL/SEAGULL

*KENSINGTON MAPLE IS ALMOST IDENTICAL TO SUGAR MAPLE – REFER TO PHYSICAL SAMPLES*

FOR ACCURACY OF COLOR/TEXTURE/FINISH PLEASE REFER TO PHYSICAL SAMPLES

# BREAKROOM

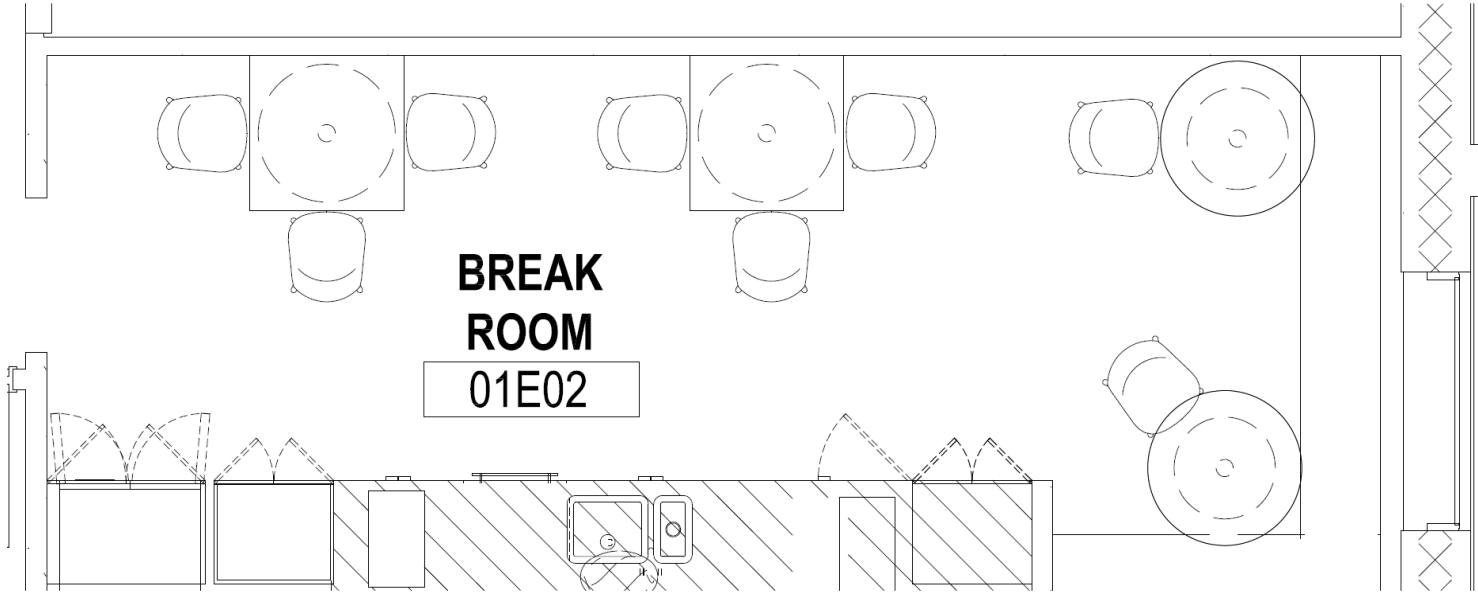

# BREAKROOM

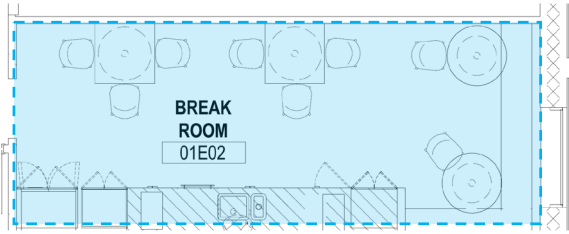

## ATHENS TABLES

36" DIA (QTY. 2)

36"SQ (QTY. 2) SQ. EDGES

### FINISHES:

TOP: FRSOTY WHITE LAMINATE

EDGE: BLACK

BASE: COTTONWOOD WHITE

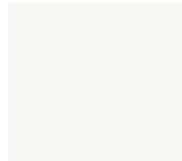

LAMINATE: FROSTY WHITE



EDGE: BLACK

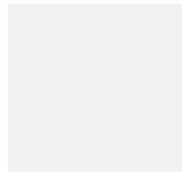

METAL BASE: TBD



## CHAIR OPTIONS:



## MOLLIE CHAIR

QTY: 8

UPHOLSTERY: MAHRARAM:

ARTICLE/GRAVEL

BASE: CLEAR WOOD STAIN



MAHARAM:  
ARTICLE/GRAVEL

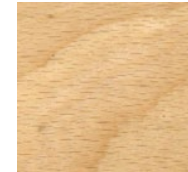

CLEAR WOOD STAIN

# CONFERENCE 01D02

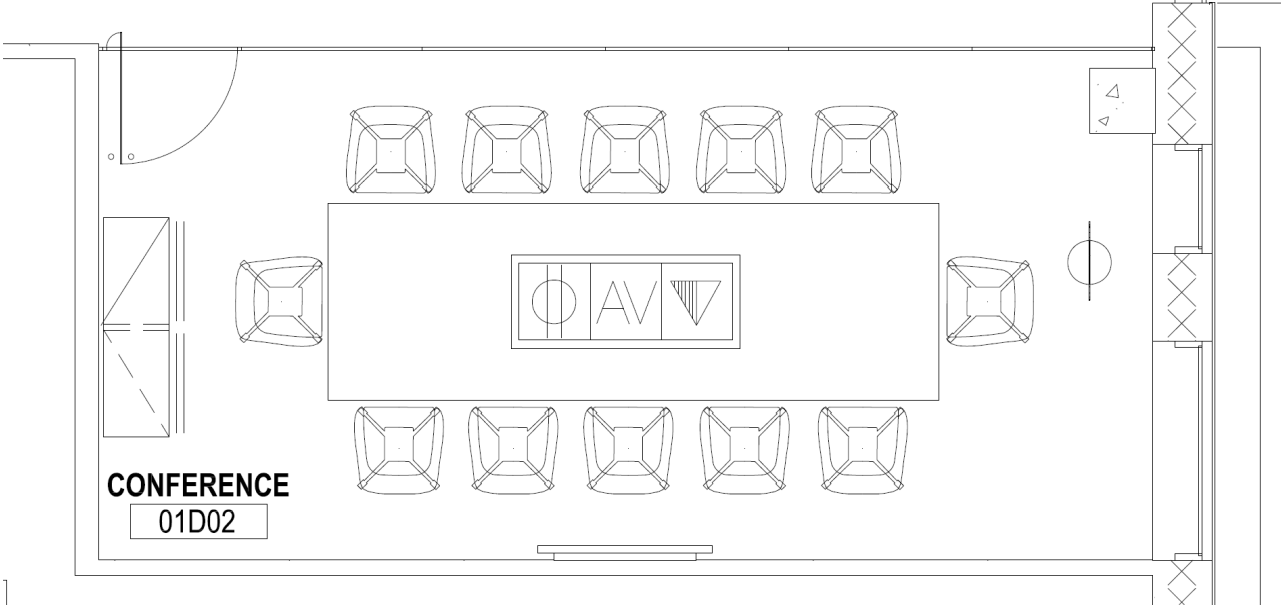

# CONFERENCE 01D02

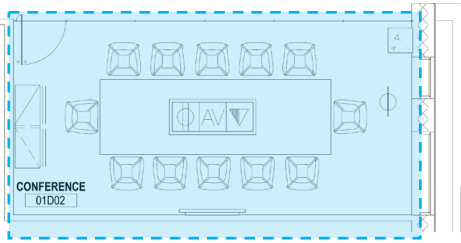

**CZ MEETING TABLE**  
**KNIFE EDGE \*POWER MODULE**

54" D x 14'

FINISHES:

TOP: VENEER NATURAL ON BEECH

BASE: NATURAL ON BEECH

METAL FRAME :  
CONTTONWOOD WHITE



NATURAL ON BEECH VENEER



LEG: NATURAL ON BEECH

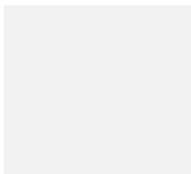

METAL FRAME: WHITE



**RIBBED CONFERENCE CHAIR**

QTY: 12

FINISHES:

UPHOLSTERY: GREY

BASE/FRAME: CHROME



UPHOLSTERY GREY

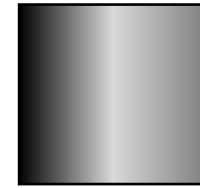

METAL BASE: CHROME



**CANVAS 4 DOOR CREDENZA**

18" D x 60" W

FINISHES:

LAMINATE: DESIGNER WHITE

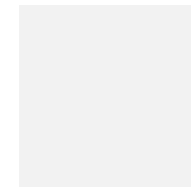

LAMINATE: DESIGNER WHITE



METAL PULLS



# HEAD OF SCHOOL

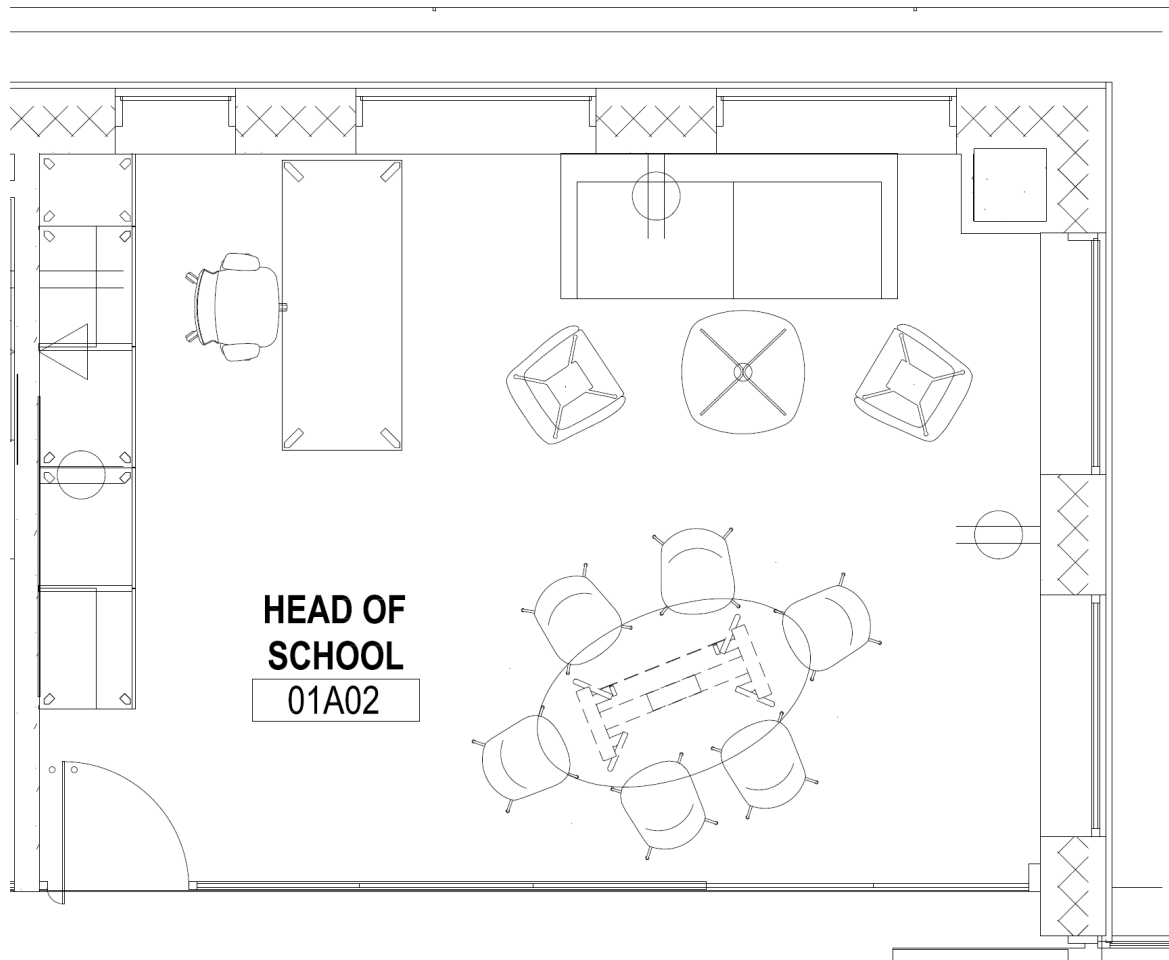

HEAD OF SCHOOL

# HEAD OF SCHOOL

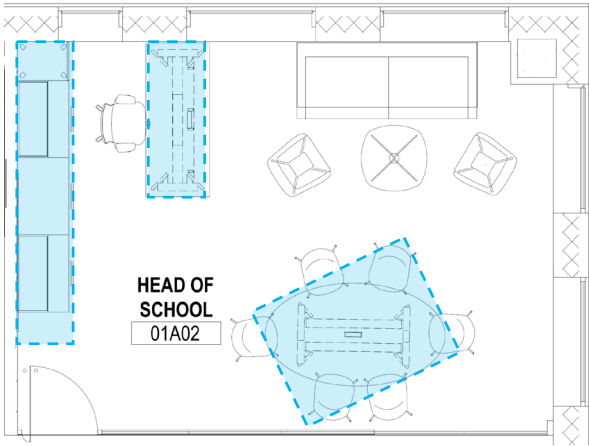

**CZ DESK**  
 30"D x 72"W  
**FINISHES:**  
 TOP: LAMINATE DESIGNER WHITE  
 EDGE: WHITE  
 BASE: NATURAL ON BEECH  
 METAL FRAME: COTTONWOOD WHITE

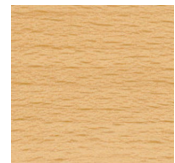
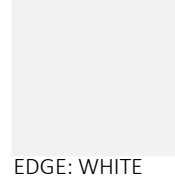

**CZ ELLIPTICAL MEETING TABLE**  
**KNIFE EDGE \*POWER MODULE**  
 42"D x 84"  
**FINISHES:**  
 TOP: DESIGNER WHITE  
 LAMINATE  
 EDGE: WHITE  
 BASE: NATURAL ON BEECH  
 METAL FRAME:  
 COTTONWOOD WHITE



**CANVAS MODULAR LATERALS WITH COMMON TOP IN WHITE**  
 36"W x 24"D  
**(QTY. 3)**  
**FINISHES:**  
 LAMINATE A: DESIGNER WHITE  
 LAMINATE B: SUGAR MAPLE  
 PULLS: ALUMINUM

LAMINATE A: DESIGNER WHITE



FILE PULLS



**CANVAS CASEGOODS**  
**(2) STACK ON BOOKCASES – NO DOORS**  
**(1) WARDROBE UNIT**  
**FINISHES:**  
 LAMINATE: SUGAR MAPLE  
 PULLS: ALUMINUM (WARDROBE)

# HOS-OPTION 2

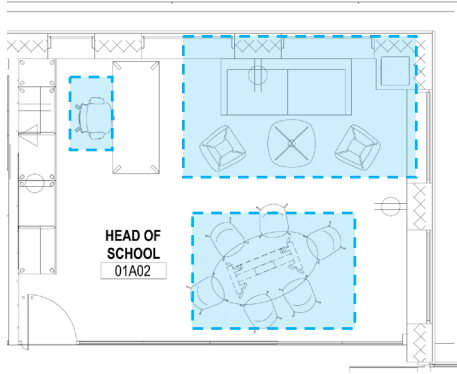

## ADAMS SOFA

84"W (QTY. 1)

FINISHES:

UPHOLSTERY: INDIGO

BASE: SILVER



INDIGO



BASE: SILVER

## CHAIR AROUND TABLE



## CALIDA SWIVEL CHAIR

QTY: 6

FINISHES:

UPHOLSTERY: PALLAS:  
PANACHE/DEEP SEA

BASE/FRAME: POLISHED  
ALUMINUM



PANACHE: DEEP SEA



METAL BASE:

POLISHED ALUMINUM

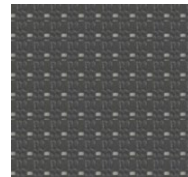

MESH: GREY



POLY: BLACK



KNOLL JOURNEY/JINGLE

## OUSBY TASK CHAIR

QTY. 1

FINISHES:

MESH: GREY

COMPONENTS: BLACK

UPHOLSTERY: KNOLL: JOURNEY/JINGLE

## CHAIRS BY SOFA



## OPEN LOUNGE CHAIR

4-STAR SWIVEL ON GLIDES

QTY: 2

FINISHES:

UPHOLSTERY: DESIGNTEX ROCKET/LINEN

BASE/FRAME: CHROME



MAHARAM:  
MESSENGER/ICE



METAL BASE:

POLISHED CHROME



## SPIRIT ROUND TABLE

(QTY. 1)

FINISHES:

TOP: SUGAR MAPLE

BASE: ALUMINUM

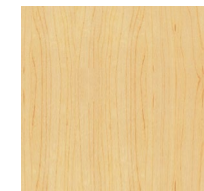

LAMINATE: SUGAR  
MAPLE



BASE: ALUMINUM

FOR ACCURACY OF COLOR/TEXTURE/FINISH PLEASE REFER TO PHYSICAL SAMPLES

ADMIN OFFICES:

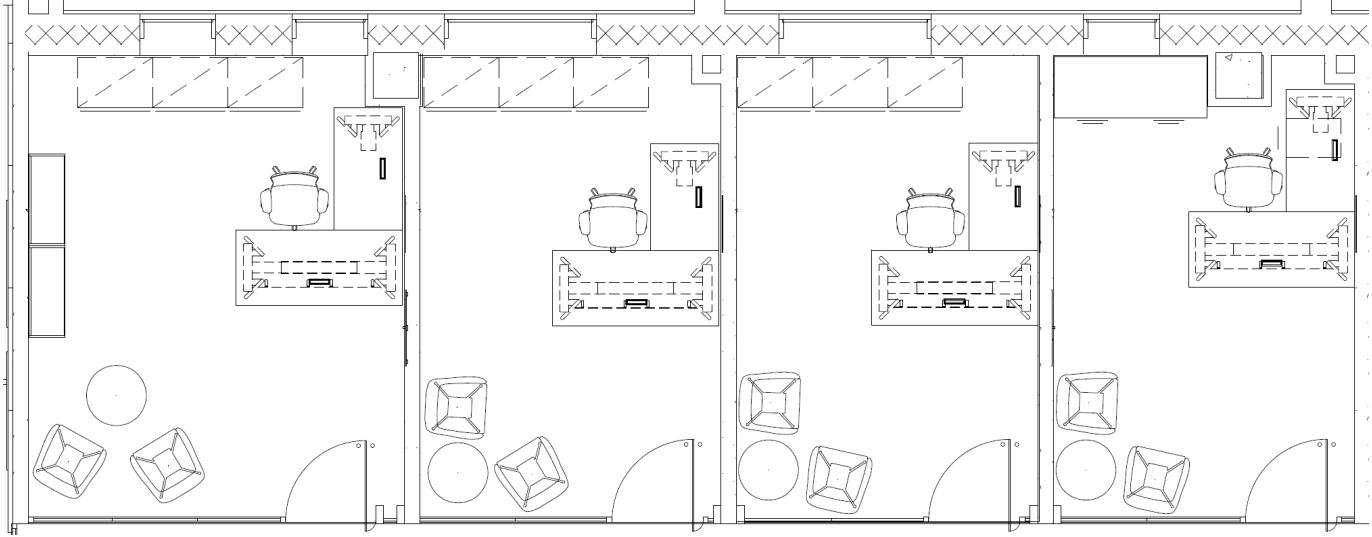

BUSINESS SUITE

MARKETING

DEAN OF STUDENTS

ASST. HEAD OF SCHOOL

# BUSINESS SUITE



## CZ DESK WITH RETURN

30"D x 72"W MAIN  
27"D x 48"W RETURN

### FINISHES:

TOP: LAMINATE DESIGNER WHITE  
EDGE: FROSTY WHITE  
BASE: NATURAL ON BEECH  
METAL FRAME: COTTONWOOD WHITE  
\*GROMMETS ON CENTER OF WORKSURFACES

LAMINATE:  
DESIGNER WHITE

FRAME: WHITE

WOOD LEG STAIN:  
NATURAL ON BEECH

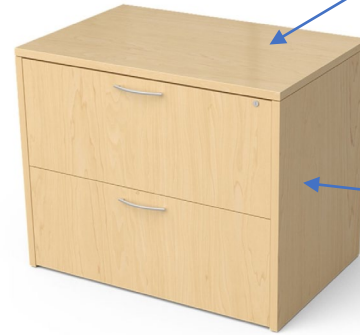

## CANVAS MODULAR LATERALS WITH COMMON TOP IN WHITE 30"W x 24"D (QTY. 3)

FINISHES:  
LAMINATE A: WHITE  
LAMINATE B: SUGAR MAPLE  
PULLS: ALUMINUM

LAMINATE A: WHITE

LAMINATE B: SUGAR  
MAPLE

FILE PULLS



## CALIDA SWIVEL CHAIR QTY: 2

### FINISHES:

UPHOLSTERY: MAHARAM  
MODE/STROLL  
BASE/FRAME: POLISHED  
ALUMINUM

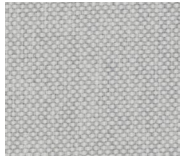

MAHARAM  
MODE/STROLL



METAL BASE:  
POLISHED ALUMINUM



LAMINATE B: SUGAR  
MAPLE

## CANVAS FREESTANDING BOOKCASE

36"W x 72"H

QTY: 2

### FINISHES:

LAMINATE: SUGAR MAPLE



LAMINATE: FUSION  
MAPLE



CHROME BASE

## CONIC SIDE TABLE

16"H x 24"ROUND (QTY. 1)

### FINISHES:

TOP: FUSION MAPLE  
BASE: SILVER

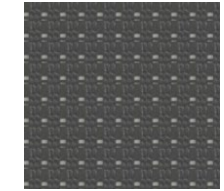

MESH: GREY



POLY: BLACK

## OUSBY TASK CHAIR

QTY. 1

### FINISHES:

MESH: GREY  
COMPONENTS: BLACK  
UPHOLSTERY: KNOLL: JOURNEY/JINGLE



KNOLL:  
JOURNEY/JINGLE



# MARKETING



## CZ DESK WITH RETURN

30"D x 66"W MAIN  
27"D x 42"W RETURN

### FINISHES:

TOP: LAMINATE FROSTY WHITE  
EDGE: DESIGNER WHITE  
BASE: NATURAL ON BEECH  
METAL FRAME: COTTONWOOD WHITE  
\*GROMMETS ON CENTER OF WORKSURFACES

LAMINATE:  
DESIGNER WHITE

FRAME: WHITE

WOOD LEG STAIN:  
NATURAL ON BEECH

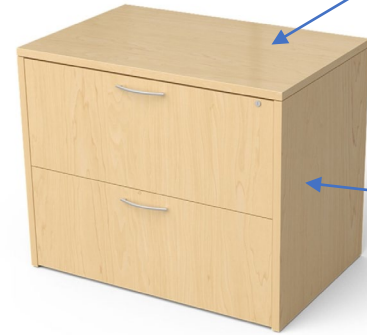
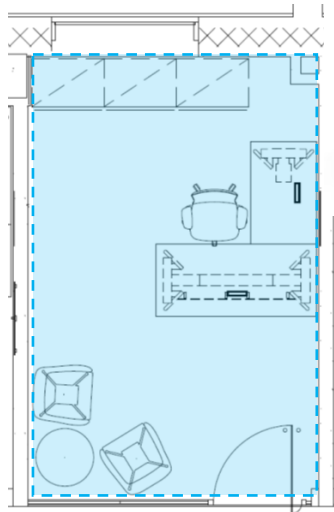

## CANVAS MODULAR LATERALS WITH COMMON TOP IN WHITE

30"W x 24"D  
(QTY. 3)

### FINISHES:

LAMINATE A: DESIGNER WHITE  
LAMINATE B: SUGAR MAPLE  
PULLS: ALUMINUM

LAMINATE A: DESIGNER WHITE

LAMINATE B: SUGAR MAPLE

FILE PULLS



## CALIDA SWIVEL CHAIR

QTY: 2

### FINISHES:

UPHOLSTERY: MAHARAM MODE/STROLL  
BASE/FRAME: POLISHED ALUMINUM

MAHARAM  
MODE/STROLL

METAL BASE:  
POLISHED ALUMINUM



## CONIC SIDE TABLE

16"H x 24" ROUND (QTY. 1)

### FINISHES:

TOP: FUSION MAPLE  
BASE: SILVER

LAMINATE: FUSION  
MAPLE

CHROME BASE



MESH: GREY

POLY: BLACK

KNOLL:  
JOURNEY/JINGLE

## OUSBY TASK CHAIR

QTY. 1

### FINISHES:

MESH: GREY  
COMPONENTS: BLACK  
UPHOLSTERY: KNOLL: JOURNEY/JINGLE

# DEAN OF STUDENTS

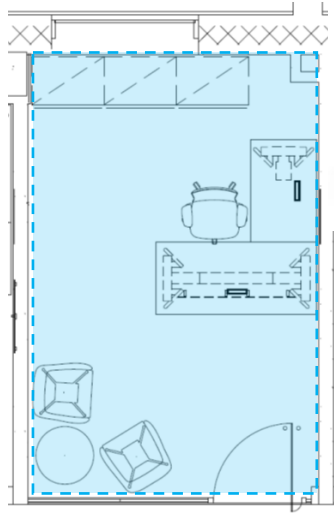

## CZ DESK WITH RETURN

30"D x 66"W MAIN  
27"D x 42"W RETURN  
FINISHES:  
TOP: LAMINATE DESIGNER WHITE  
EDGE: FROSTY WHITE  
BASE: NATURAL ON BEECH  
METAL FRAME: COTTONWOOD WHITE  
\*GROMMETS ON CENTER OF WORKSURFACES

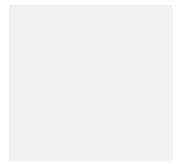

LAMINATE:  
DESIGNER WHITE



FRAME: WHITE



WOOD LEG STAIN:  
NATURAL ON BEECH

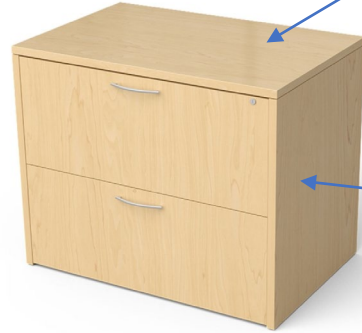

## CANVAS MODULAR LATERALS WITH COMMON TOP IN WHITE

30"W x 24"D  
(QTY. 3)  
FINISHES:  
LAMINATE A: DESIGNER WHITE  
LAMINATE B: SUGAR MAPLE  
PULLS: ALUMINUM

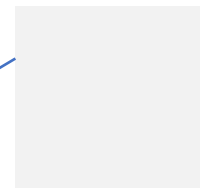

LAMINATE A: DESIGNER WHITE



LAMINATE B: SUGAR MAPLE



FILE PULLS



## CALIDA SWIVEL CHAIR

QTY: 2  
FINISHES:  
UPHOLSTERY: MAHARAM MODE/STROLL  
BASE/FRAME: POLISHED ALUMINUM

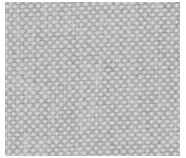

MAHARAM  
MODE/STROLL



METAL BASE:  
POLISHED ALUMINUM



## CONIC SIDE TABLE

16"H x 24" ROUND (QTY. 1)  
FINISHES:  
TOP: FUSION MAPLE  
BASE: SILVER

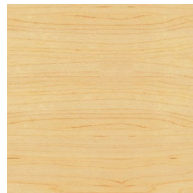

LAMINATE: FUSION MAPLE



CHROME BASE



MESH: GREY



POLY: BLACK



KNOLL:  
JOURNEY/JINGLE

## OUSBY TASK CHAIR

QTY. 1  
FINISHES:  
MESH: GREY  
COMPONENTS: BLACK  
UPHOLSTERY: KNOLL: JOURNEY/JINGLE



# ASST. HEAD OF SCHOOL



## CZ DESK WITH RETURN

30"D x 66"W MAIN  
27"D x 48"W RETURN  
FINISHES:  
TOP: LAMINATE DESIGNER WHITE  
EDGE: FROSTY WHITE  
BASE: NATURAL ON BEECH  
METAL FRAME: COTTONWOOD WHITE  
\*GROMMETS ON CENTER OF WORKSURFACES

LAMINATE:  
DESIGNER WHITE

FRAME: WHITE



WOOD LEG STAIN:  
NATURAL ON BEECH



## CANVAS DOUBLE LATERAL FILE 60"W X 24"D

FINISHES:  
LAMINATE A: DESIGNER WHITE  
LAMINATE B: SUGAR MAPLE  
PULLS: ALUMINUM

LAMINATE A:  
DESIGNER WHITE

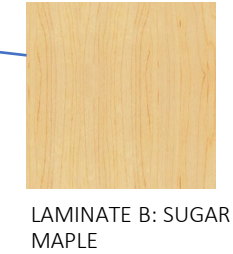

LAMINATE B: SUGAR  
MAPLE



FILE PULLS



## CALIDA SWIVEL CHAIR QTY: 2

FINISHES:  
UPHOLSTERY: MAHARAM  
MODE/STROLL  
BASE/FRAME: POLISHED  
ALUMINUM

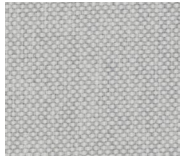

MAHARAM  
MODE/STROLL



METAL BASE:  
POLISHED ALUMINUM



## CZ BOX/FILE MOBILE PED QTY: 1

FINISHES:  
METAL: COTTONWOOD  
WHITE  
UPHOLSTERY: PALLAS:  
FRIEZE/HUDSON

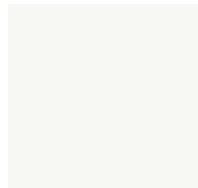

METAL:  
COTTONWOOD  
WHITE

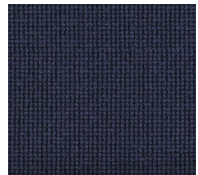

UPHOLSTERY: PALLAS  
FRIEZE/HUDSON



## CONIC SIDE TABLE

16"H x 24" ROUND (QTY. 1)  
FINISHES:  
TOP: FUSION MAPLE  
BASE: SILVER

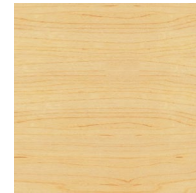

LAMINATE: FUSION  
MAPLE



CHROME BASE



## OUSBY TASK CHAIR QTY. 1

FINISHES:  
MESH: GREY  
COMPONENTS: BLACK  
UPHOLSTERY:  
KNOLL: JOURNEY/JINGLE



MESH: GREY

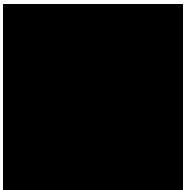

POLY: BLACK



KNOLL:  
JOURNEY/JINGLE

ATHLETIC DIR. OFFICE

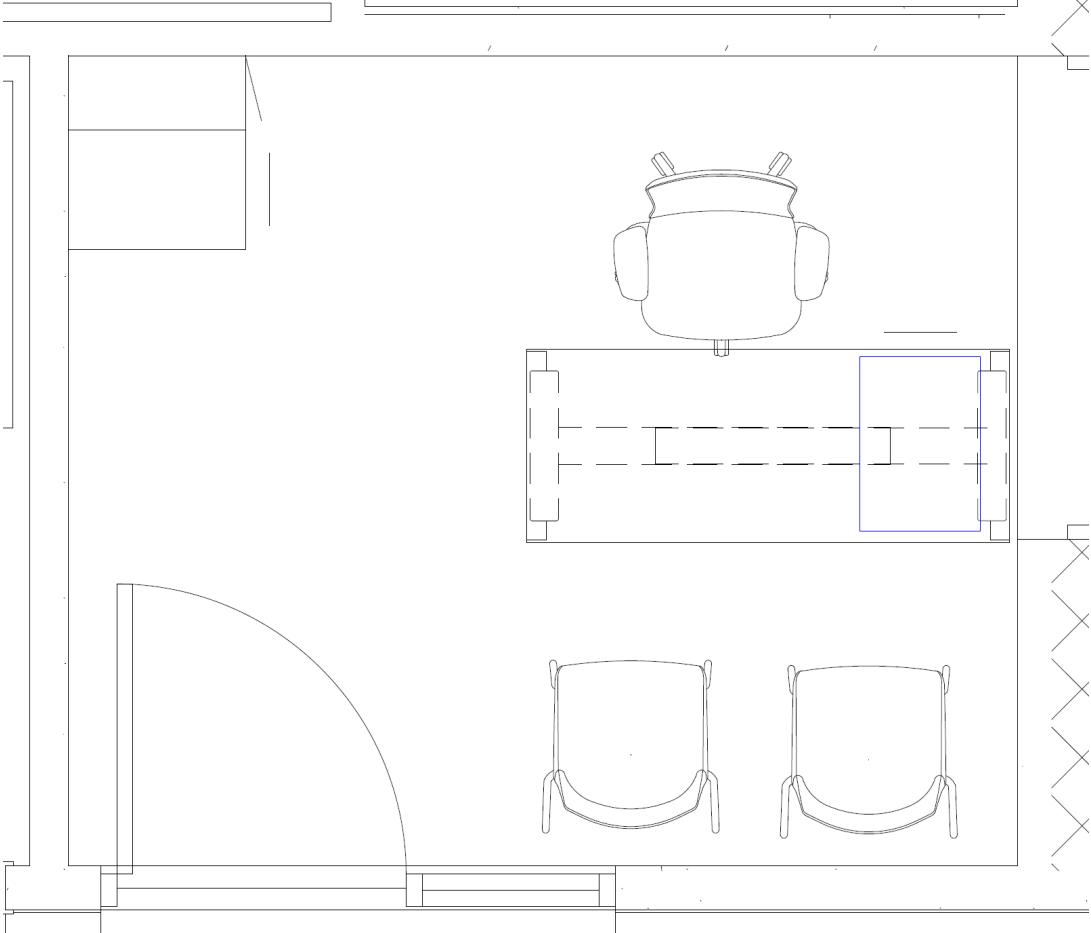

# ATHLETIC DIR. OFFICE

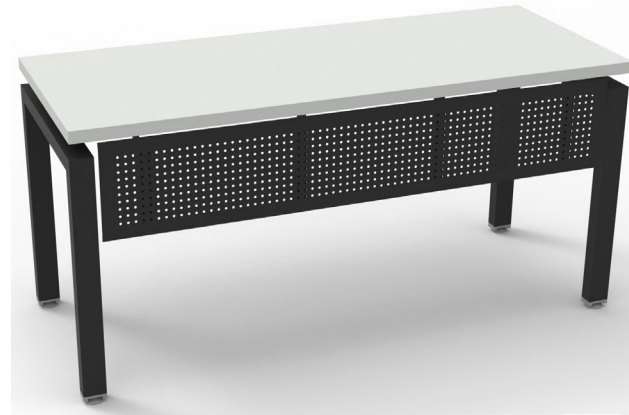
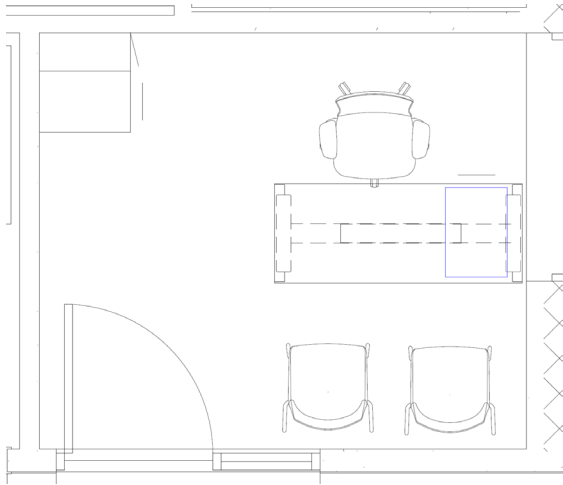

**CZ METAL FRAME DESK**

24"D x 60"W

FINISHES:

LAMINATE: FROSTY WHITE/FROSTY WHITE EDGE

METAL FRAME/MODESTY: BLACK

\*ADD CENTER GROMMET

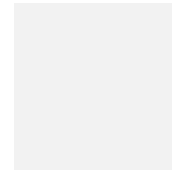

LAMINATE:  
FROSTY WHITE



METAL:  
BLACK

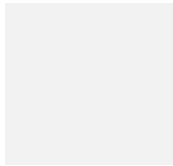

METAL:  
COTTONWOOD  
WHITE

**USERIES STORAGE**

**WARBDRÖBE, OPEN BOOKCASE, B/B/F**

FINISHES:

METAL: COTTONWOOD WHITE

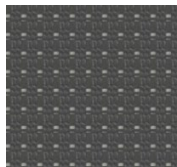

MESH: GREY

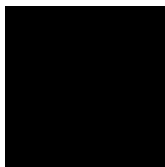

POLY: BLACK



KNOLL:  
JOURNEY/JINGLE

**OUSBY TASK CHAIR**

QTY. 1

FINISHES:

MESH: GREY

COMPONENTS: BLACK

UPHOLSTERY: KNOLL: JOURNEY/JINGLE



**CZ BOX/FILE MOBILE PED**

QTY: 1

FINISHES:

METAL: COTTONWOOD WHITE

UPHOLSTERY: PALLAS:

FRIEZE/HUDSON

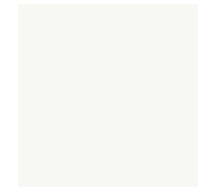

METAL:  
COTTONWOOD  
WHITE



UPHOLSTERY: PALLAS  
FRIEZE/HUDSON



POLY: NORDIC



BASE: BLUEGREY

**DONI 4-LEG CHAIR**

QTY. 2

FINISHES:

POLY: NORDIC BLUE

BASE FRAME: BLUEGREY

# FOLDING CHAIRS IN GYM



## 600S FOLDING CHAIRS

### FINISHES:

NORDIC FRAME  
STONE HENGE VINYL  
TOP/SEAT LOGO